

SPECIFICATIONS

INPUT:	8 x VGA D-Sub 15 pin Female connector, 8x3.5mm block connector for balance/un-balance audio
OUTPUT:	8 x VGA D-Sub 15 pin Female connector, 8x3.5mm block connector for balance/un-balance audio
COM PORT:	1 x 9 pin D-Sub Female connector
BANDWIDTH:	(-3dB) 900MHz
MAX RESOLUTION:	1600 x 1200
SIGNAL TYPE:	VGA, SVGA, XGA, UXGA, Multi sync
CABLE LENGTH (INPUT):	1 to 3 meter
CABLE LENGTH (OUTPUT):	1 to 50 meter (*Depending on cable rating)
POWER SOURCE:	100 to 230 VAC, 50/60Hz
DIMENSIONS:	(430 x 240 x 130)mm Weight:1350g
HOUSING:	Metal
ACCESSORIES:	Power cord

** For detail and updated RS-232 Command protocol for programming, please visit and download from www.abtussingapore.com

* Specifications are subject to changes without notice.

Configuration Diagram:

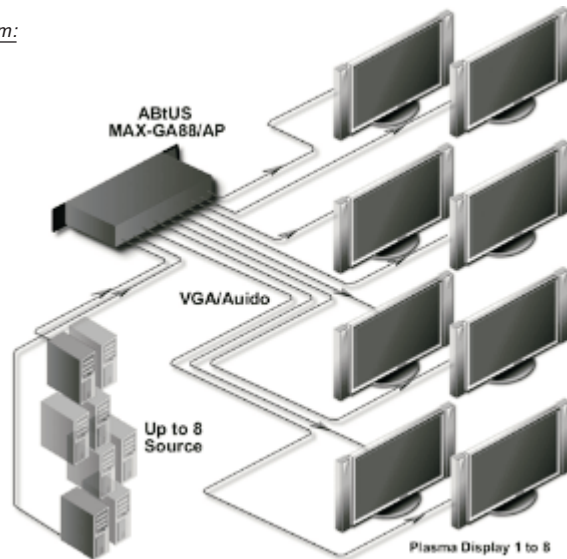

ABtUS
S I N G A P O R E

Matrix Switcher



Model: MAX-GA88/AP



Model: MAX-GA84AP

- With the 8 Input arrangements, any of the 8 video/audio sources can now be the selectively amplified and distributed with highly transparent even for high-resolution VGA modes like UXGA to any of the 8 display panels. It is ideal for presentation systems requiring 8 VGA sources with 8 difference display units.
- Compatible with all monitors, projectors, HDTV and flat panels display.

PRODUCT DESCRIPTION

The **ABtUS MAX-GA88/AP** Matrix is specially designed for computer and workstation applications. Either one or any 1 or up to 8 VGA/SVGA/XGA/UXGA graphic input can be split or route to any 1 or up to 8 output with no discernible signal degradation. State-of-the-art power management circuitry makes MAX-GA88/AP the first choice signal distributor. With its high signal bandwidth of 900MHz identical high defined output through out can be achieved.

1. FRONT PANEL VIEW

Model: **MAX-GA88/AP**

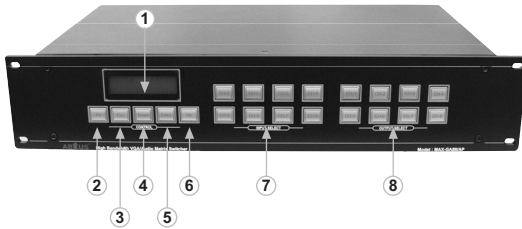

- | Item | Description |
|------|--|
| 1. | LCD display which shows the current system status |
| 2. | "Fn" Function key, entering into setup menu |
| 3. | "Esc" selection |
| 4. | "Down" selection |
| 5. | "Enter" key |
| 6. | "Up" key |
| 7. | Input Channel Select, Selection of the input port 1 to 8 |
| 8. | Output Channel Select, Selection of the output port 1 to 8 |

2. BACK PANEL VIEW

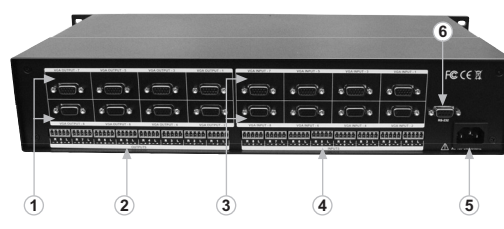

- | Item | Description |
|------|---|
| 1. | VGA 15pin Output port 1 to 8 |
| 2. | Balanced/Unbalanced Audio Output port 1 to 8 |
| 3. | VGA 15pin Input port 1 to 8 |
| 4. | Balance/Unbalance Audio Input port 1 to 8 |
| 5. | Power Input plug. Before plugging in the power, please check if power is AC 100~230V, 50/60Hz |
| 6. | RS-232 I/O control port |

Model: **MAX-GA84/AP**

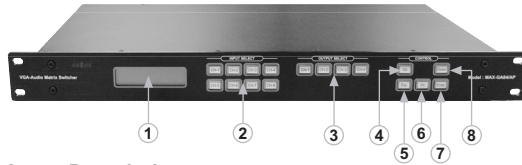

- | Item | Description |
|------|--|
| 1. | LCD display which shows the current system status |
| 2. | Input Channel Select, Selection of the input port 1 to 8 |
| 3. | Output Channel Select, Selection of the output port 1 to 4 |
| 4. | "Fn" Function key, entering into setup menu |
| 5. | "Enter" selection |
| 6. | "Up" selection |
| 7. | "Down" key |
| 8. | "Esc" key |

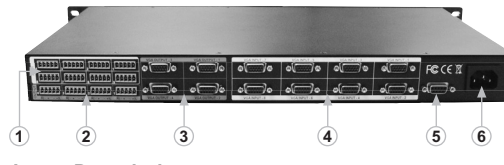

- | Item | Description |
|------|---|
| 1. | Balance/Unbalance Audio Input port 1 to 8 |
| 2. | Balanced/Unbalanced Audio Output port 1 to 4 |
| 3. | VGA 15pin Output port 1 to 4 |
| 4. | VGA 15pin Input port 1 to 8 |
| 5. | RS-232 I/O control port |
| 6. | Power Input plug. Before plugging in the power, please check if power is AC 100~230V, 50/60Hz |

BALANCED/UNBALANCED AUDIO CONNECTIONS

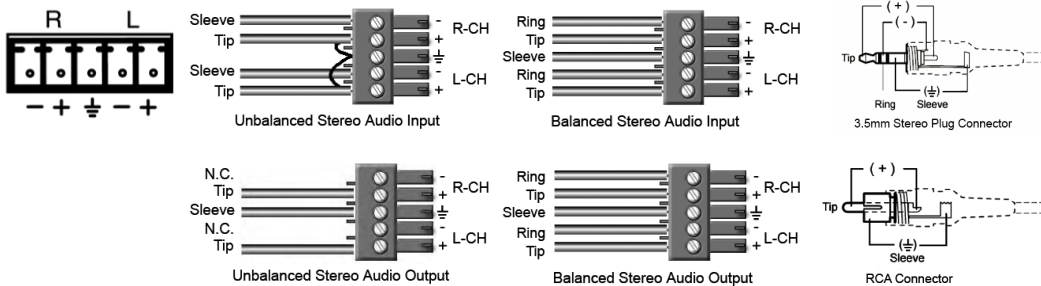

28	Get Audio input Gain level.	SETC41X31xxx xxx is port select. xxx = 001,002,....	RETC71X31xxxyyy xxx is port select. xxx = 001,002,.... yyy is gain level. yyy = 001,002,....
29	Get Video Channel Mute state.	SETC41Y3zxxxx z is in/out port setting. z = 0, getting output port. z = 1, getting input port.. xxx is port select. xxx = 001,002,....	RETC51Y3zxxxxy z is in/out port getting. z = 0, getting output port. z = 1, getting input port.. xxx is port select. xxx = 001,002,.... y is mute state. y = 0, is mute. y = 0, is unmute.
30	Get Audio Channel Mute state	SETC41A3zxxxx z is in/out port setting. z = 0, getting output port. z = 1, getting input port.. xxx is port select. xxx = 001,002,....	RETC51A3zxxxxy z is in/out port setting. z = 0, getting output port. z = 1, getting input port.. xxx is port select. xxx = 001,002,.... y is mute state. y = 0, is mute. y = 0, is unmute.
31	Detect Video input channel signal state	SETC41b31xxx. xxx is port select. xxx = 001,002,....	RETC51b31xxxxy xxx is select port. xxx = 001,002,.... y is input signal state. y = 0, no signal detect. y = 1, had signal detect.
32	Get Support stated for : Independence Video and Audio switching	SETC01i3	RETC11i3x x indicates whether the system support independence Video and Audio switching x = 0, NOT Supported x = 1, Support
33	RS232 control code no support		RETC0!

20	Load Preset Item.	SETC30e3xxx xxx is load item. xxx = 001,002,....	1. When there is the "Preset" stored. RETC30e3xxx xxx is load item. xxx = 001,002,.... 2. When there isn't any "Preset" stored. RETC0!
21	Factory reset	SETC00U0	RETC00U0
22	Get Power State.	SETC01P3	RETC11P3x. x is power state. x = 0, is poweroff x = 1, is power on.
23	Get Panel Lock state.	SETC01L3	RETC11L3x. x is panel lock state. x = 0, is panel unlock. x = 1, is panel lock.
24	Get Video output port Source state	SETC61S3yyy yyy is output port. yyy = 001,002,....	RETC61S3xxxyyy yyy is output port. yyy = 001,002,.... 1. When a Output port is connected to a Input port. xxx is input port. xxx = 001,002,.... 2. When NO input port is connected. xxx = 000.
25	Get Audio output port Source state	SETC6013yyy yyy is output port. yyy = 001,002,....	RETC61g3xxxyyy yyy is output port. yyy = 001,002,.... 1. When a Output port is connected to a Input port. xxx is input port. xxx = 001,002,.... 2. When NO input port is connected xxx = 000
26	Get volume level.	SETC41V30xxx. xxx is port select. xxx = 001,002,....	RETC71V30xxxyyy xxx is select port . xxx = 001,002,.... yyy is volume level. yyy = 001,002,....
27	Get Video input/output Gain level.	SETC41W3zxxx z is in/out gain select. z = 0, select output gain. z = 1, select input gain. xxx is port select. xxx = 001,002,....	RETC71W3zxxxyyy z is in/out gain select. z = 0, select output gain. z = 1, select input gain. xxx is port select. xxx = 001,002,.... yyy is gain level. yyy = 001,002,....

SYSTEM FUNCTION

3. FUNCTION: 0 FUNCTION MENU SETUP PAGE

(1) Entering "Setup Menu page"

To enter "Setup Menu" press the "Fn" button once, LCD Display will shows the function menu accordingly. Select the relevant function by using the "Up" and "Down" button and confirm selection by pressing the "Enter" button.

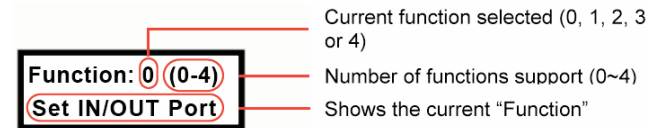

(2) Setting up the I/O port

Enter the setup menu page and select "Set IN/OUT Port" function and press "Enter". LCD display will show "Select IN/OUT Port." By using the "Up" and "Down" button select the desire switching mode. i.e. Video/Audio, Video Only or Audio Only and confirm by pressing the "Enter" button. The LCD display will then show "IN, OUT" and the "Input Select" buttons will be blinking. Select the desire Input port number by pressing the respective buttons. Once selected the LCD will display the respective Input port number and the buttons back light will stay ON. Select the desired Input and Output ports by pressing the Input and Output Channel Selection buttons or deselect by pressing the same button again.

Steps are as followed:

■ Example:

1. Press "Fn" button to enter Setup Menu page, making use of the Up/Down button and move to "Set Input/Output Port" function and press "Enter"



2. Enter "Select I/O Port" function and again making use of the Up/Down button to select the Video and or Audio switching mode i.e. Video/Audio, Video Only or Audio Only.

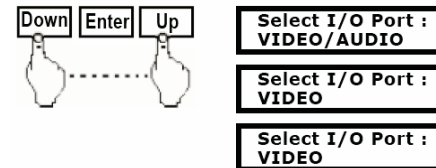

3. The front panel "Input Select" buttons will be flashing waiting for selection.

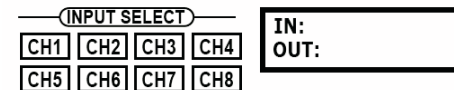

Assuming that the current setup is with Input port 1 routed to Output port 1 to 8.

Hence, if Input Select CH1 is pressed, all Output Port buttons from 1 to 8 will be lighted. And these Input/Output port number will also be shown on the LCD display accordingly.

Therefore if any other Input Select Channel (Port 2 to Port 8) is selected the Output Select Buttons will NOT be lighted up. "Up" and "Down" can be used to scroll if Output select is more than 6

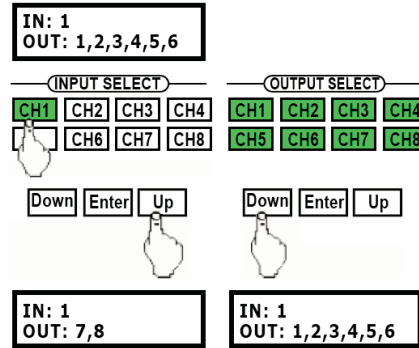

4. And NOW if Input Channel 2 is to be routed to Output port 2, 4, and 5. The settings up are as follows:

Select the "Input Select" button CH2 and select the "Output Select" Ch2, Ch4 and CH5. Back light for all selected buttons will stay ON.

And these Input and Output port number will also be shown on the LCD display accordingly.

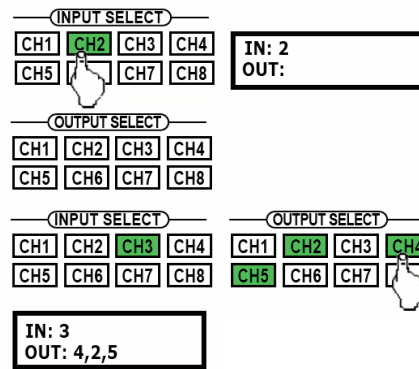

Press the respective button again to "Cancel" a selection when required, the respective button will go off together with the displayed port number on the LCD.

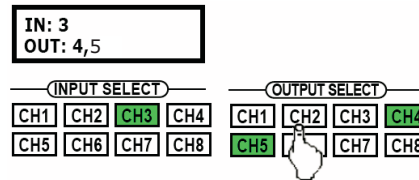

Then press the "Enter" button to confirm and store the setting. The LCD Menu display will then return to "IN, OUT" page and the "Input Select" buttons will now flashing waiting for selection. Repeat step number 3 to set another I/O routing or if different "Video" and or "Audio" channel switching model is required, press "Esc" to return to "Select I/O Port" page and repeat Step number 2.

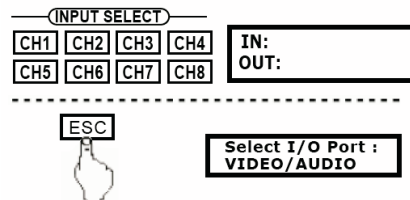
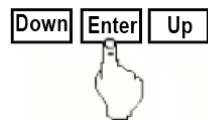

And just press the "Enter" button again if other I/O setting is required.

14	Video input/output Gain Level up/down.	SETC50t3zxxxxy z is in/out gain select. z = 0, select output gain. z = 1, select input gain. xxx is port select. xxx = 001,002,.... y is up/down setting. y = 0, Level up. y = 1, Level down. If xxx = 000, indicates that Video Gain will take effect on all the Video Input or Output Port.	SETC70W3zxxxxyy. z is in/out gain select. z = 0, select output gain. z = 1, select input gain. xxx is port select. xxx = 001,002,.... yyy is gain level. yyy = 001,002,.... If xxx = 000, indicates that Video Gain will take effect on all the Video Input or Output Port and the "Gain Level" will base on the last adjusted port as reference.
15	Audio input Gain Level Setting.	SETC70X31xxxxyy xxx is port select. xxx = 001,002,.... yyy is gain level. yyy = 001,002,.... If xxx = 000, indicates that Audio Input Gain will take effect on all the Audio Port.	RETC70X31xxxxyy xxx is port select. xxx = 001,002,.... yyy is gain level. yyy = 001,002,.... If xxx = 000, indicates that Audio Input Gain will take effect on all the Audio Port.
16	Audio input t Gain Level up/down.	SETC50u31xxxxy xxx is output port. xxx = 001,002,.... y is up/down setting. y = 0, Level up. y = 1, Level down. If xxx = 000, indicates that Audio Input Gain will take effect on all the Audio Port.	RETC70X31xxxxyy xxx is port select. xxx = 001,002,.... yyy is gain level. yyy = 001,002,.... If xxx = 000, indicates that Audio Input Gain will take effect on all the Audio Port and the "Gain Level" will base on the last adjusted port as reference.
17	Video Channel Mute.	SETC50Y3zxxxxy z is in/out port setting. z = 0, setting output port. z = 1, setting input port.. xxx is port select. xxx = 001,002,.... y is mute setting. y = 0, is mute. y = 0 , is un-mute.	RETC50Y3zxxxxy z is in/out port setting. z = 0, setting output port. z = 1, setting input port.. xxx is port select. xxx = 001,002,.... y is mute setting. y = 0, is mute. y = 0 , is un-mute.
18	Audio Channel Mute.	SETC50A3zxxxxy z is in/out port setting. z = 0, setting output port. z = 1, setting input port.. xxx is port select. xxx = 001,002,.... y is mute setting. y = 0, is mute. y = 0 , is un-mute.	RETC50A3zxxxxy z is in/out port setting. z = 0, setting output port. z = 1, setting input port.. xxx is port select. xxx = 001,002,.... y is mute setting. y = 0, is mute. y = 0 , is un-mute.
19	Save Preset Item.	SETC30f3xxx xxx is save item. xxx = 001,002,....	1. When a "Preset" is setup accordingly and is ready to "Save". RETC30f3xxx xxx is save item. xxx = 001,002,.... 2. When there isn't any "Preset" done to be "save". RETC0!

6	Audio Source Select.	SETC60g3xxxxyy xxx is input source. xxx = 001,002,.... yyy is output source. yyy = 001,002,....	RETC60g3xxxxyy xxx is input source. xxx = 001,002,.... yyy is output source. yyy = 001,002,....
7	Video/Audio Source select	SETC60j3xxxxyy xxx is input source. xxx = 001,002,.... yyy is output source. yyy = 001,002,....	RETC60j3xxxxyy xxx is input source. xxx = 001,002,.... yyy is output source. yyy = 001,002,....
8	Turn off video channel	SETC40m3zxxx z is in/out port setting. z = 0, setting output z = 1, setting input xxx is port select. xxx = 001,002,....	RETC40m3zxxx z is in/out port setting. z = 0, setting output port. z = 1, setting input port. xxx is port select. xxx = 001,002,....
9	Turn off audio channel	SETC40n3zxxx z is in/out port setting. z = 0, setting output z = 1, setting input xxx is port select. xxx = 001,002,....	RETC40n3zxxx z is in/out port setting. z = 0, setting output port. z = 1, setting input port. xxx is port select. xxx = 001,002,....
10	Turn off video/audio channel	SETC40p3zxxx z is in/out port setting. z = 0, setting output port. z = 1, setting input port. xxx is port select.	RETC40p3zxxx z is in/out port setting. z = 0, setting output port. z = 1, setting input port. xxx is port select.
11	Volume Level Setting	SETC70V30xxxxyy. xxx is output port. xxx = 001,002,.... yyy is volume level. yyy = 001,002,.... If xxx = 000, indicates that Volume Level will take effect on all the Audio Output Port.	RETC70V30xxxxyy. xxx is output port. xxx = 001,002,.... yyy is volume level. yyy = 001,002,.... If xxx = 000, indicates that Volume Level will take effect on all the Audio Output Port.
12	Volume Level up/down	SETC50r30xxxxy xxx is output port. xxx = 001,002,.... y is up/down setting. y = 0, Volume up. y = 1, Volume down. If xxx = 000, indicates that Volume Level will take effect on all the Audio Output Port.	RETC70V30xxxxyy. xxx is output port. xxx = 001,002,.... yyy is volume level. yyy = 001,002,.... If xxx = 000, indicates that Volume Level will take effect on all the Audio Output Port.
13	Video input/output Gain Level Setting.	SETC70W3zxxxxyy. z is in/out gain select. z = 0, select output gain. z = 1, select input gain. xxx is port select. xxx = 001,002,.... yyy is gain level. yyy = 001,002,.... If xxx = 000, indicates that Video Gain will take effect on all the Video Input or Output Port.	SETC70W3zxxxxyy. z is in/out gain select. z = 0, select output gain. z = 1, select input gain. xxx is port select. xxx = 001,002,.... yyy is gain level. yyy = 001,002,.... If xxx = 000, indicates that Video Gain will take effect on all the Video Input or Output Port.

5. Now assuming that the setup is with Input Channel 1 routed to Output Channel 1, 3, 6, 7 and 8. To remove the output route "Output port" 3 and 8. Follows the steps as below:

IN: 1
OUT: 1,6,7

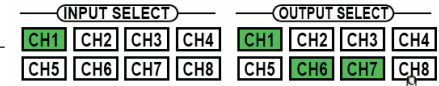

Follows the steps as shown:

6. Based on the above steps, press "Input Select" CH1 then followed by Output Select CH3 and CH8. The buttons will stay ON and LCD display will show the channel selected accordingly.

Press "Enter" to confirm setting.

Notes:

Setting will NOT be stored if "Fn" or "Esc" is pressed instead of "Enter". And all settings will remain as before.

(3) FUNCTION 1: VIDEO AND AUDIO GAIN CONTROL

Function: 1 (0-4) Gain Adjust

The Gain adjust function allows the user to set the Video/Audio IN and OUT gain accordingly for every single port independently.

Steps are as follows:

1. Press "Fn" to enter Function Menu, making use of the Up/Down button and select "Gain Adjust" function and press Enter for confirmation.



2. In "Select I/O Gain :" Menu, making use of the Up/Down button to select the desired channel to be adjusted.

Namely: VIDEO IN Gain or VIDEO OUT Gain, AUDIO IN Gain.

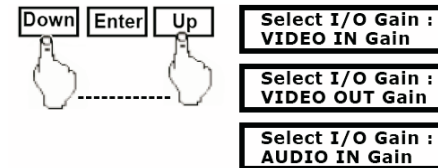

3. If the above selection was "VIDEO IN Gain" the LCD display will show "Select Port :" accordingly and the INPUT SELECT buttons will be flashing to indicate that the system is waiting for selection.

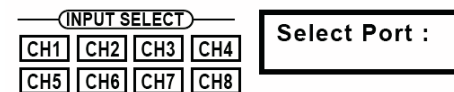

4. Select the desired IN port by selecting from the INPUT SELECT buttons. Select 1→2→6→4 and press "Enter". The Input gain level will then be based on port 1 as reference.

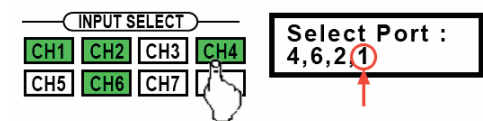

- In the "Gain Level" Menu, and making use of the Up/Down button and select the desire gain level accordingly and press "Enter" once confirm. The gain level selected will then be stored accordingly

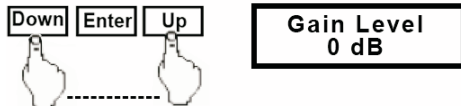

The system will then return to "Select Port:" Menu and the "INPUT SELECT" buttons will be flashing again indicates that the system is waiting for selection. Repeat step number 3 to select other ports.

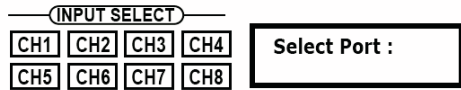
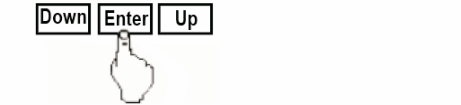

If a new I/O Gain selection is required, press "Esc" return to "I/O Gain:" Menu and repeat steps number 2 accordingly.



Notes: Setting will NOT be stored if "Fn" or "Esc" is press instead of "Enter" And all setting will remain as before.

4. FUNCTION 2: VOLUME ADJUST

The Volume adjust function allows user to set the Audio Output volume accordingly for every single port.

Steps are as followed:

- Press "Fn" to enter Function Menu, making use of the Up/Down button and select "Volume Adjust" function and select Enter for confirmation.



- In "Select Port:" Menu, "OUTPUT SELECT" buttons will be flashing indicates that the system is waiting for a selection.



- Select the desired Output port by selecting form the OUTPUT SELECT buttons. Select 2→3→6→ 4 and press "Enter". The Output gain level will then based on port 2 as reference.

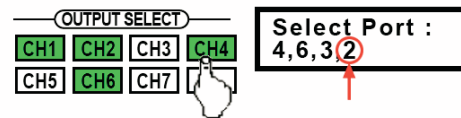

Cancellation of "Panel Lock" can be done by press and hold the Up/Down button again for 1 to 2 sec till two beeps sound is heard. The "Panel Lock" will go off accordingly.

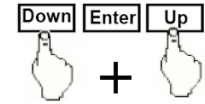

Note:

The "Panel Lock" will also be disable once a power reset is performed

9. SYSTEM INITIAL

This will allow the system to be reset to factory preset mode.

SYSTEM INITIAL

Steps are as followed:

- Remove the AC power source
- Press and hold "INPUT SELECT" button CH1 and CH3
- Then apply AC power source

The LCD Display will show "SYSTEM INITIAL" indicating the system is now back to initial setting and it will then return to "Main Menu"

RS-232 Protocol and Control Command

(1) Parameter setting

Baud Rate: 9600 bps
 Data Length: 8 bits
 Parity: Non parity
 Stop bit: One bit
 X on/off: None

(2) RS-232 Connection

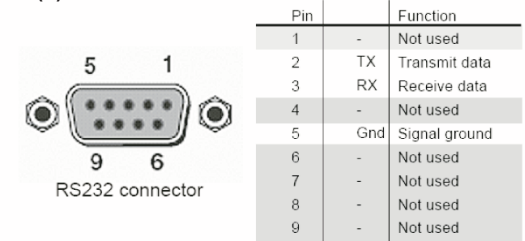

(3) RS-232 Command Code

Item	Function	Command Code	Return Code
1	Power on	SETC10P31	RETC10P31
2	Power off	SETC10P30	RETC10P30
3	Panel Lock	SETC10L31	RETC10L31
4	Panel Unlock.	SETC10L30	SETC10L30
5	Video Source Select.	SETC60S3xxxyyy xxx is input source. xxx = 001,002,.... yyy is output source. yyy = 001,002,....	RETC60S3xxxyyy xxx is input source. xxx = 001,002,.... yyy is output source. yyy = 001,002,....

4. If a temporarily muting of routing is required. One can select the desired routing mode i.e. VIDEO/AUDIO for both Video and Audio channel together, VIDEO for Video ONLY or AUDIO for Audio ONLY by using the Up/Down button as above.

Then press and hold the desired Input or Output channel directly from the front panel "INPUT SELECT" or "OUTPUT SELECT" respectively for 1 to 2 sec. The respective channel will be temporary MUTE and the button will now stay flashing after two beeps.

Example:

To temporary "MUTE" the Video and Audio of the Input channel 3, in "VIEW" Menu select "VIDEO/AUDIO mode. Then press and hold the "INPUT SELECT" button CH3 for 1 to 2 sec till a two beeps sound is heard. Now both the Video and Audio are temporary "MUTE" and the "INPUT SELECT" CH3 button will be flashing

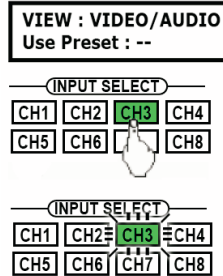

Cancellation of the "MUTE" can be done by press and hold the same button for 1 to 2 sec again till two beeps sound is heard. The button will stay ON

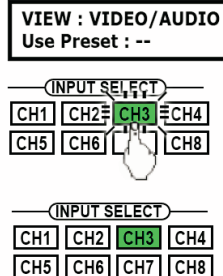

To temporary "MUTE" the Video/Audio of the Output channel 4, in "VIEW" Menu select "VIDEO/AUDIO mode. Then press and hold the "OUTPUT SELECT" button CH4 for 1 to 2 sec till a two beep sound is heard. Now both the Video and Audio are temporary "MUTE" and the "OUTPUT SELECT" CH4 button will be flashing

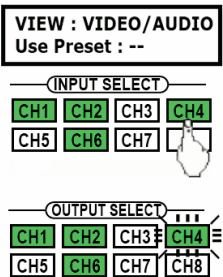

Cancellation of the "MUTE" can be done by press and hold the same button for 1 to 2 sec again till two beeps sound is heard. The button will stay ON

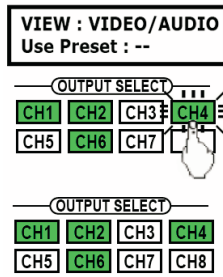

VIEW : VIDEO/AUDIO
Use Preset : --

The "Use Preset : ." within the "VIEW" Menu indicates that the system is set to rout according to the Preset stored.

VIEW : VIDEO/AUDIO
Use Preset : 2

"Use Preset : 2" means that there is a "Recall Preset" done and the system is now routing base of the stored preset number 2

Notes: All "temporarily mute" setting will be reset once any of the following is performed:

1. Power reset
2. "Set IN/OUT" setting
3. "Gain Adjust"
4. "Volume Adjust"

8. PANEL LOCK AND UNLOCK

Panel lock, disable the use or control from all the front panel buttons. In Main Menu, press and hold both Up and Down button for 1 to 2 sec till two beep sound is heard. And a "Panel Lock" will be displayed accordingly as shown.

Matrix VGA 8 X 8



Matrix VGA 8X8
Panel Lock

4. In the "Volume Level" Menu, use the Up/Down button and select the desire Volume level accordingly and press "Enter" once confirm. The Volume level selected will then be stored accordingly.



The system will then return to "Select Port:" Menu and the "OUTPUT SELECT" buttons will be flashing again indicates that the system is waiting for selection. Repeat step number 2 to select other ports.



To setup a new Volume Setting, returning to the "Volume Adjust:" function can be done by pressing "Esc" and repeat step number 2 accordingly.

Notes: Setting will NOT be stored if "Fn" or "Esc" is press instead of "Enter" And all setting will remain as before.

5. FUNCTION 3: SAVE PRESET

Function: 3 (0-4)
Save Preset

The "Save Preset" function allows user to store the Audio/Video routing configuration. A total of 10 different of such configuration can be stored which also has the availability of "Naming" each of these Preset accordingly.

Steps are as followed:

1. Press "Fn" to enter Function Menu, making use of the Up/Down button and select "Save Preset" function and select Enter for confirmation.



2. In "Save to Preset" Menu, again making use of the Up/Down button and select the desire Preset number. The respective Preset number will be displayed on LCD display with "<empty>".

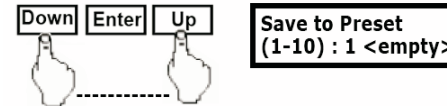

3. And press "Enter" to confirm the Preset Number selected. A cursor will appear flashing indicate that the system is waiting user to "Name" the Preset selected. A total of 5 characters can be entered accordingly with the use of the Up/Down button.

Press "Fn" to back space when required

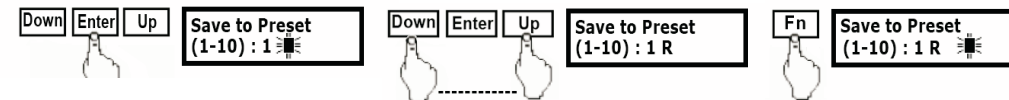

- Last press "Enter" to confirm the Preset Name. the "Preset" will be stored and the system will return to the Main Menu page as shown.

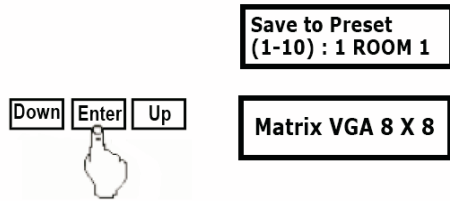

Notes: Setting will NOT be stored if "Fn" or "Esc" is press instead of "Enter" And all setting will remain as before.

6. FUNCTION 4: RECALL PRESET

Function: 4 (0-4) Recall Preset

The "Recall Preset" function allows user to recall a stored Audio/Video routing configuration preset. A total of 10 different of such configuration can be stored and recalled base on the setting which also make easy identification with its different "Naming" for each of these Preset accordingly.

Steps are as followed:

- Press "Fn" to enter Function Menu, making use of the Up/Down button and select "Recall Preset" function and select Enter for confirmation.



- In "Load from Preset" Menu, making use of the Up/Down button and select the desire Preset number. The respective Preset number will be displayed on LCD display together with the Preset Name "e.g. ROOM1" accordingly. Press "Enter" to confirm selection.

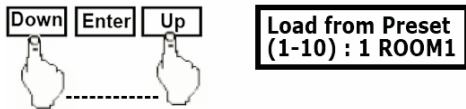

When a "empty" shown with a Preset, this indicates that there is no Preset function stored in the selected Preset Number.

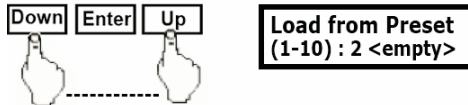

- Press "Enter" once a selection is confirmed and the system will execute the function and display will return to it's main Menu as shown. If "Enter" is press within a "<empty>" Preset number, the system will ONLY sound with a beep tone indicating an error operation.

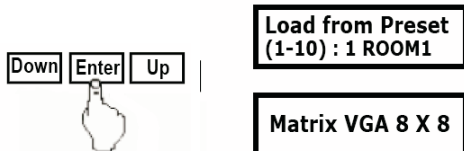

If "Enter" is press within a "<empty>" Preset number, the system will ONLY sound with a beep tone indicating an error operation.

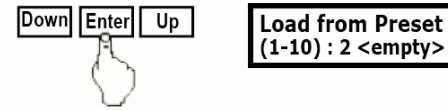

7. STATUS DISPLAY AND TEMPORALLY MUTING THE I/O ROUTING SETTING

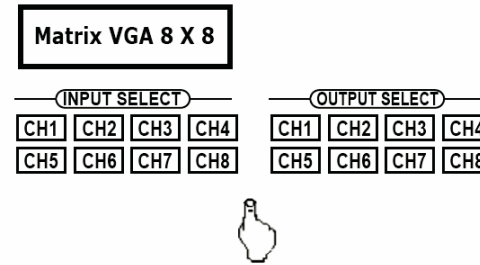

Steps are as followed:

- Assume that the current routing setting is Video/Audio Input port 3 to Video/Audio Output port 1, 2, 4 and 6. In the main Menu, Pressing the "INPUT SELECT" CH3 or "OUTPUT SELECT" CH1, CH2, CH4 or CH6 the status display will be shown accordingly and the respective button will stays ON

VIEW : VIDEO/AUDIO Use Preset : --

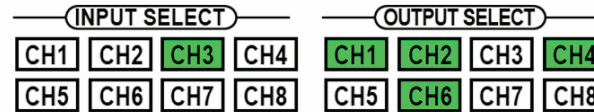

- In the main Menu, use the Up/Down button to select the "VIEW" function and press "Enter" to confirm
- Within the "VIEW" Menu, use the Up/Down button again to select the desired Video/Audio, Video ONLY or Audio ONLY channel to be "Viewed".

